

**BRAMKI DO ZACZEPU  
ELEKTROMAGNETYCZNEGO**

**SW 027.010 - lewa**

**SW 027.020 - prawa**

Bramka wejściowa do zaczepu elektromagnetycznego, służy do kontrolowanego wejścia i wyjścia osób. Może współpracować z systemami kontroli dostępu. Otwarcie bramki, następuje tylko w jednym kierunku. Po otrzymaniu impulsu elektrycznego można bramkę otworzyć. Zamknięcie bramki następuje samoczynnie. Zasilanie z transformatora bezpieczeństwa o wtórnym napięciu znamionowym 6V, przewodem zasilającym 2 x 0,5 mm<sup>2</sup> do słupka z zaczepem. Przy większych odległościach (~20 mb) należy sprawdzić napięcie na zaciskach zaczepu, które powinno wynosić 6V (nie może być wyższe niż 12V). Bramka wykonana jest ze stali pokrytej warstwą niklowo-chromową. Bramka może pracować tylko w pomieszczeniach zamkniętych. Mocowanie bramki do utwardzonego podłoża za pomocą trzech śrub Ø8 x 120 i kołków rozporowych Ø12 x 100. Podobnie mocowany jest słupek z zaczepem.

Ciężar bramki 11,5 kG.

Ciężar słupka 5 kG.

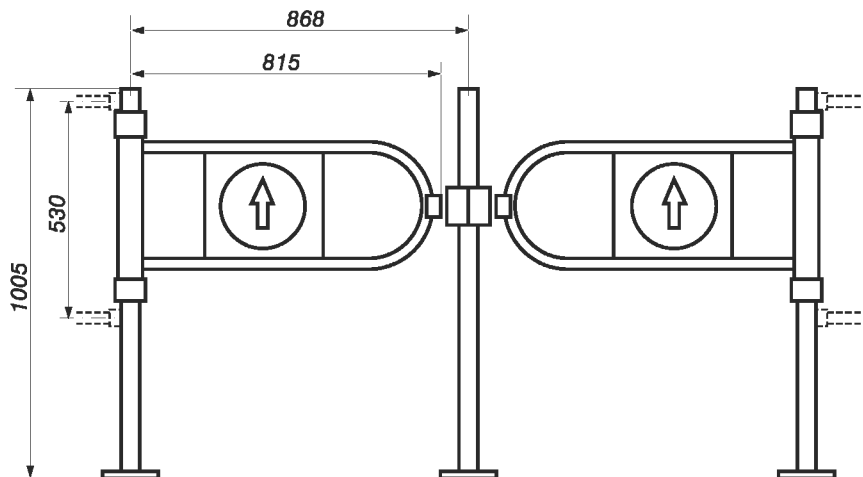
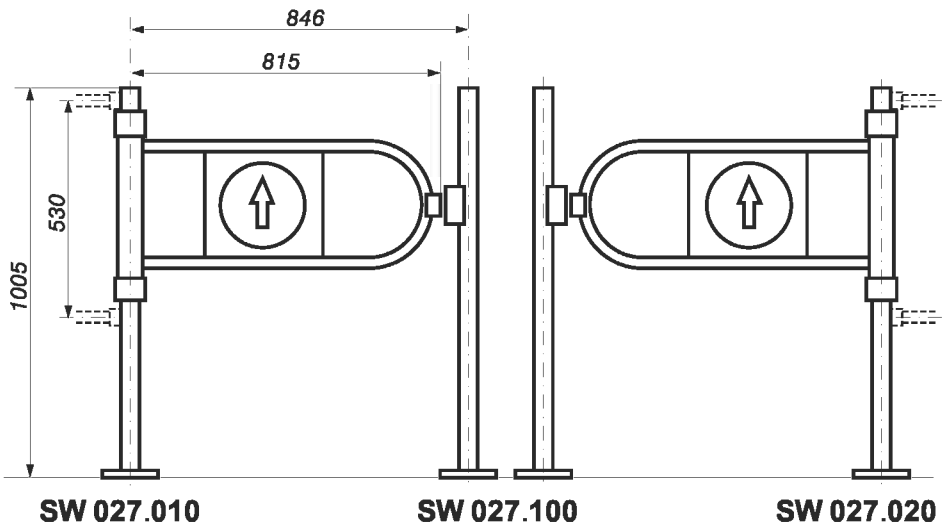

SW 027.010

SW 027.100 A

SW 027.020

**bramka – lewa**

SW 027.010



SW 027.011

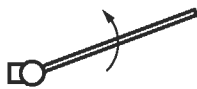

SW 027.012

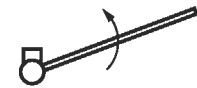

SW 027.013

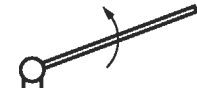

SW 027.014

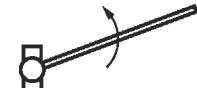

SW 027.015

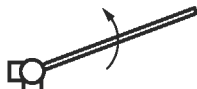

W 027.016

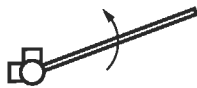

SW 027.017



**– prawa**

SW 027.020

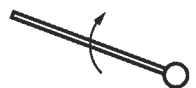

SW 027.021

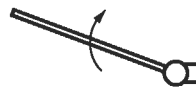

SW 027.022

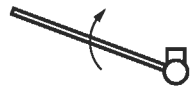

SW 027.023

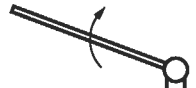

SW 027.024

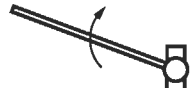

SW 027.025

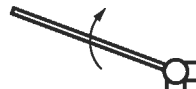

SW 027.026

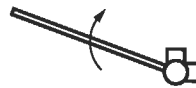

SW 027.027

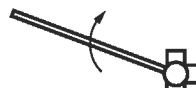

SW 027.100



SW 027.101



SW 027.102



SW 027.103



SW 027.104



SW 027.105



SW 027.106



SW 027.107



słupek z pojedynczym zaczepem

**słupek z dwoma zaczepami**

SW 027.100 A



SW 027.102 A



SW 027.104 A

